

COMPRESSORI-ASPIRATORI A CANALE LATERALE

SIDE CHANNEL COMPRESSORS AND VACUUM PUMPS

SC802PF

SC802PF7.5T / 11T



Costruiti secondo il principio dei canali laterali, funzionano sia in aspirazione sia in compressione e sono progettati per lavorare a servizio continuo. Realizzato in alluminio pressofuso garantisce la massima robustezza e maneggevolezza. Non occorre lubrificazione in quanto non c'è contatto tra le parti statiche e rotanti. Particolari silenziosi contribuiscono ad ottenere un elevato livello di silenziosità.

Construction of the ring blowers fans is based on the lateral ducts principle. The blowers can operate as either exhaust or compression fans and are designed for continuous service. The device is assembled directly on the motor shaft; all the rotating parts are dynamically balanced to ensure absolute absence of vibration. Full die-cast aluminium construction for maximum sturdiness and ease of handling.



EmmeCom s.r.l.

Via P. Nenni, 70
20093 Cologno Monzese (MI)
Tel. +39 02 25 33 300 (r.a.)
Fax +39 02 27 307 908
www.emmecomsrl.com
sales@emmecomsrl.com



Curve Curva n.	Model Modello n.	Frequency Frequenza (Hz)	Output power Potenza (kW)	Voltage Vtaggio (V)	Rated current Assorbimento (A)	Noise Rumorosità dB (A)	Weight Peso (Kg)
1	SC802PF7.5T	50	7,5	345-415Δ/600-720Y	16,7Δ/9,6Y	74	91
2	SC802PF7.5T	60	8,6	380-480Δ/660-720Y	17,3Δ/10,0Y	78	91
3	SC802PF11T	50	11,0	345-415Δ/600-720Y	28,0Δ/16,2Y	74	110
4	SC802PF11T	60	12,6	380-480Δ/660-720Y	29,0Δ/16,7Y	78	110

ASPIRAZIONE / EXHAUST

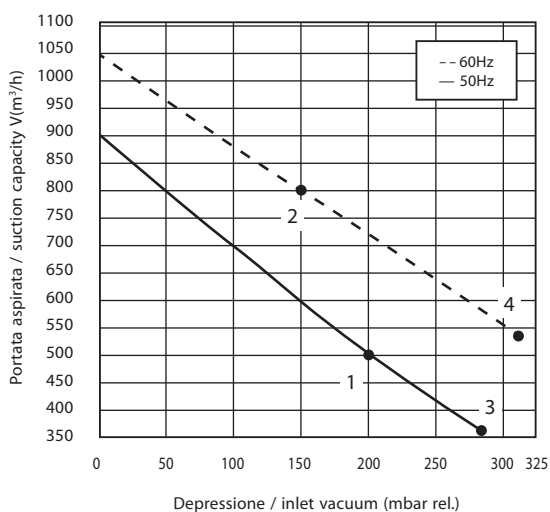

COMPRESSIONE / COMPRESSION

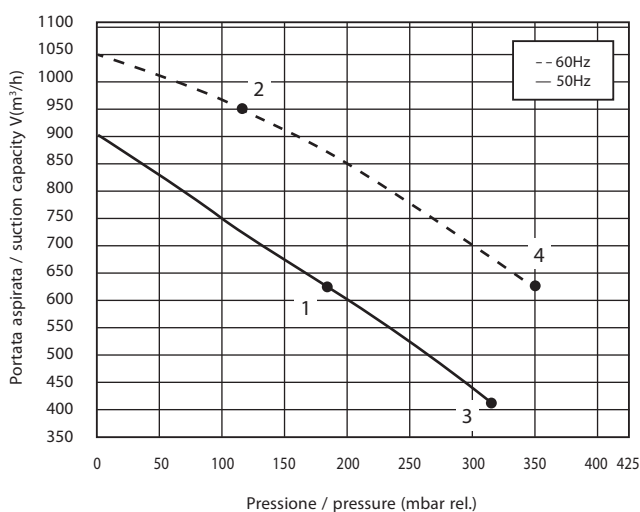

I valori di portata e pressione si intendono per il convogliamento dell'aria avente in aspirazione temperatura di 15°, densità di 1,23 kg/m³ e pressione a 1.013 mbar. La tolleranza di queste curve si intende del ±10%. I dati sopraindicati possono essere variati senza preavviso.

The characteristic data given here refer to the handling of gas with inlet temperature of 15° C, normal density of 1,23 kg/m³ and absolute pressure of 1.013 mbar. Tolerance of ±10%. The data may change without any notification.

a i r m o v i n g

COMPRESSORI-ASPIRATORI A CANALE LATERALE

SIDE CHANNEL
COMPRESSORS AND
VACUUM PUMPS

SC802PF7.5T / 11T



Dimensioni / Dimensions = mm

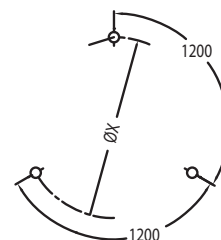
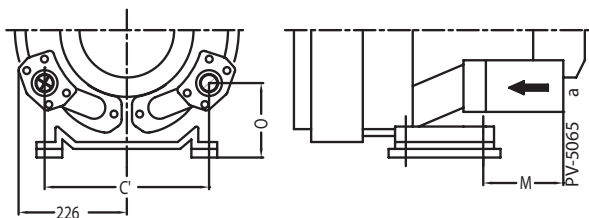
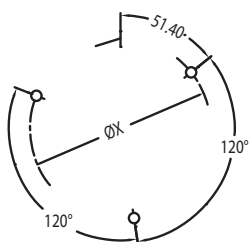
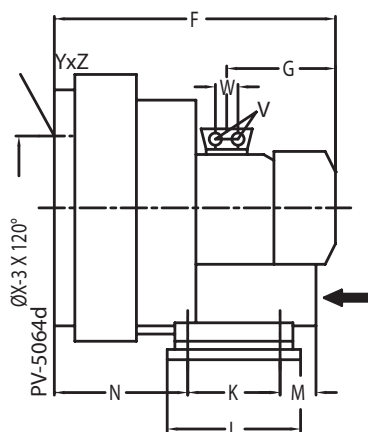
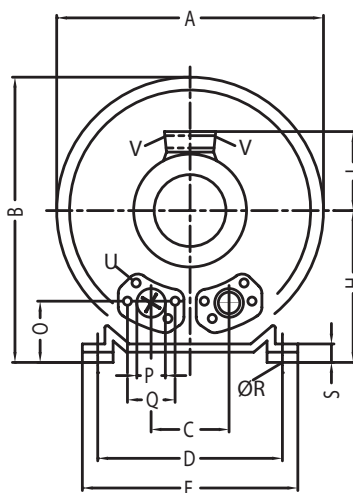

Emmecom s.r.l.

Via P. Nenni, 70
20093 Cologno Monzese (MI)

Tel. +39 02 25 33 300 (r.a.)

Fax +39 02 27 307 908

www.emmecomsrl.com

sales@emmecomsrl.com

	Phase Fase	A	B	C	C'	D	E	F	G	H	J	K	L	M	N	O	ØP	ØR	S	V	W	ØX	YxZ	X-holes X-fori
SC802PF7.5T	3~	500	550	152	-	356	394	589	247	300	167	170	217	-	236	125	G2"½	15	66	4 x M32x1.5	42	286	M12x20	0°/120°/240°
SC802PF11T	3~	500	550	-	336	356	394	694	318	300	197	170	217	312	212	165	G2"½	15	66	4 x M40x1.5	54	286	M12x20	0°/120°/240°